

FEATURES

- Complementary to MMBT5551
- Ideal for Medium Power Amplification and Switching

MARKING: 2L

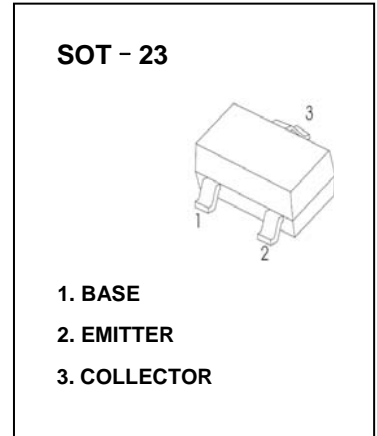

MAXIMUM RATINGS ($T_a=25^\circ\text{C}$ unless otherwise noted)

Symbol	Parameter	Value	Unit
V_{CB0}	Collector-Base Voltage	-160	V
V_{CE0}	Collector-Emitter Voltage	-150	V
V_{EBO}	Emitter-Base Voltage	-5	V
I_C	Collector Current	-0.6	A
P_C	Collector Power Dissipation	0.3	W
$R_{\theta JA}$	Thermal Resistance from Junction to Ambient	416	$^\circ\text{C}/\text{W}$
T_J, T_{stg}	Operation Junction and Storage Temperature Range	-55~+150	$^\circ\text{C}$

ELECTRICAL CHARACTERISTICS ($T_a=25^\circ\text{C}$ unless otherwise specified)

Parameter	Symbol	Test conditions	Min	Typ	Max	Unit
Collector-base breakdown voltage	$V_{(BR)CBO}$	$I_C=-100\mu\text{A}, I_E=0$	-160			V
Collector-emitter breakdown voltage	$V_{(BR)CEO}^*$	$I_C=-1\text{mA}, I_B=0$	-150			V
Emitter-base breakdown voltage	$V_{(BR)EBO}$	$I_E=-10\mu\text{A}, I_C=0$	-5			V
Collector cut-off current	I_{CBO}	$V_{CB}=-120\text{V}, I_E=0$			-0.1	μA
Emitter cut-off current	I_{EBO}	$V_{EB}=-4\text{V}, I_C=0$			-0.1	μA
DC current gain	$h_{FE(1)}^*$	$V_{CE}=-5\text{V}, I_C=-1\text{mA}$	80			
	$h_{FE(2)}^*$	$V_{CE}=-5\text{V}, I_C=-10\text{mA}$	100		300	
	$h_{FE(3)}^*$	$V_{CE}=-5\text{V}, I_C=-50\text{mA}$	50			
Collector-emitter saturation voltage	$V_{CE(sat)1}^*$	$I_C=-10\text{mA}, I_B=-1\text{mA}$			-0.2	V
	$V_{CE(sat)2}^*$	$I_C=-50\text{mA}, I_B=-5\text{mA}$			-0.5	V
Base-emitter saturation voltage	$V_{BE(sat)1}^*$	$I_C=-10\text{mA}, I_B=-1\text{mA}$			-1	V
	$V_{BE(sat)2}^*$	$I_C=-50\text{mA}, I_B=-5\text{mA}$			-1	V
Transition frequency	f_T	$V_{CE}=-5\text{V}, I_C=-10\text{mA}, f=30\text{MHz}$	100			MHz

*Pulse test: pulse width $\leq 300\mu\text{s}$, duty cycle $\leq 2.0\%$.

CLASSIFICATION OF $h_{FE(2)}$

RANK	L	H
RANGE	100-200	200-300

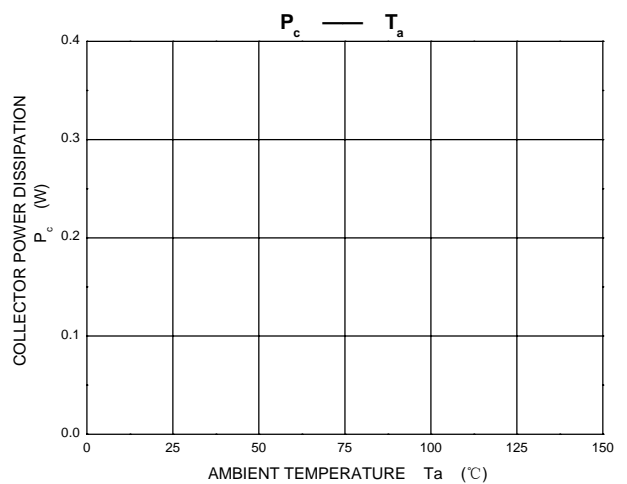
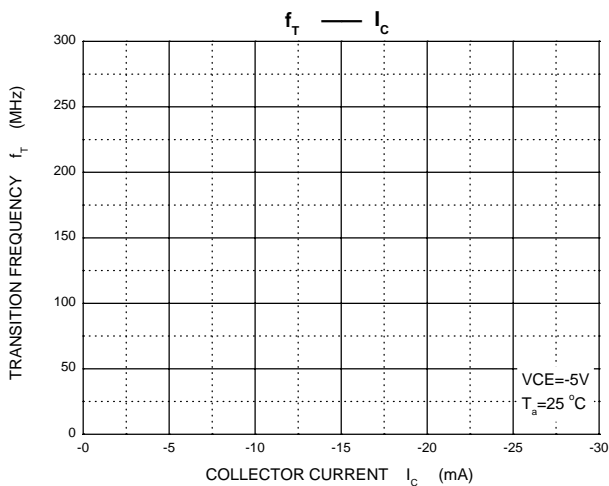
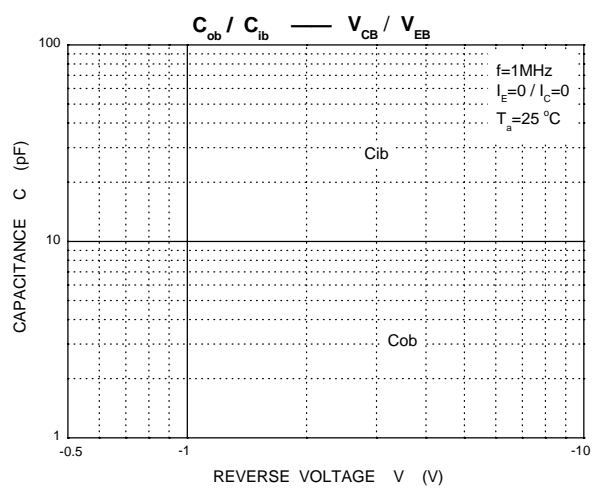
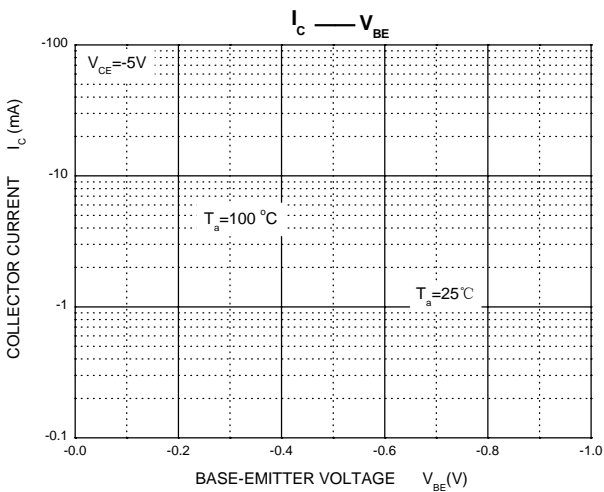
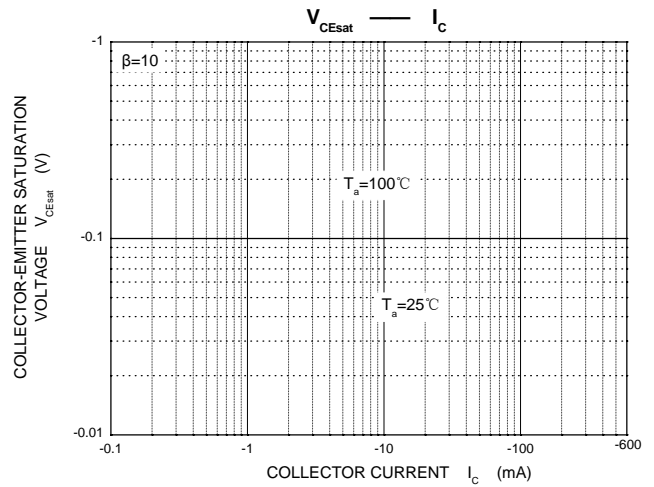
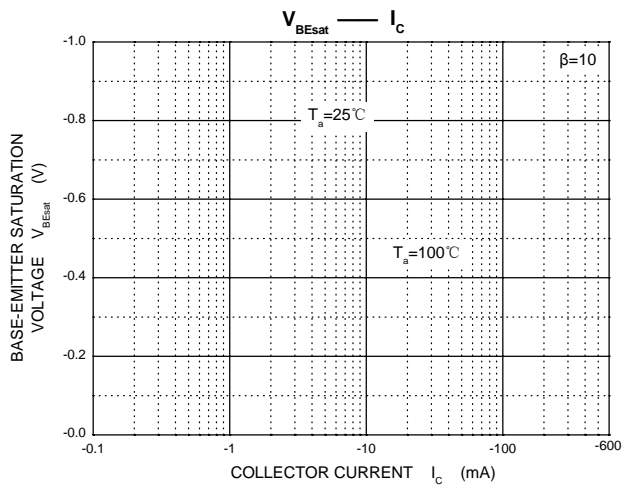
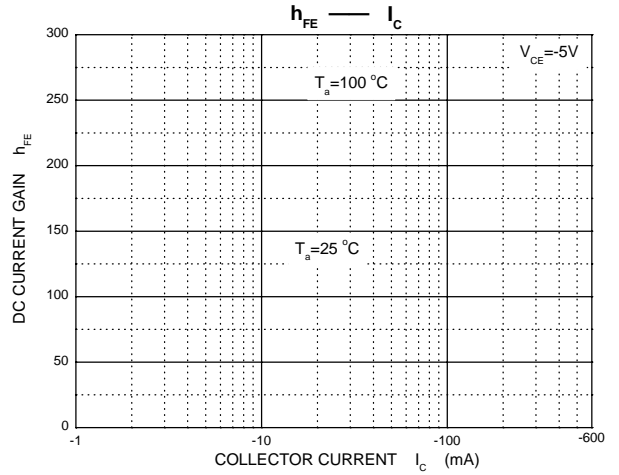
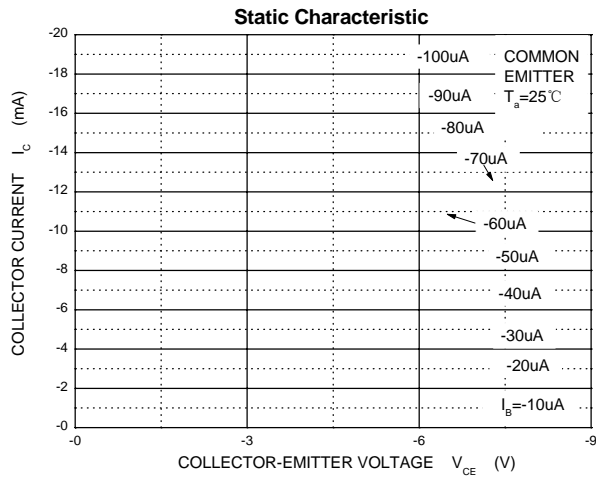

SOT-23 Package Outline Dimensions

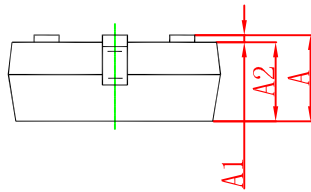
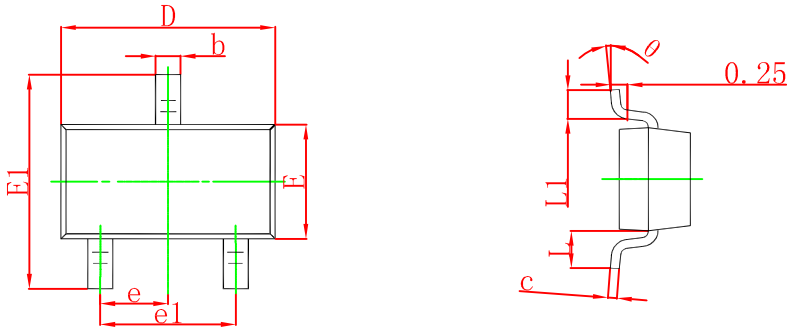

Symbol	Dimensions In Millimeters		Dimensions In Inches	
	Min	Max	Min	Max
A	0.900	1.150	0.035	0.045
A1	0.000	0.100	0.000	0.004
A2	0.900	1.050	0.035	0.041
b	0.300	0.500	0.012	0.020
c	0.080	0.150	0.003	0.006
D	2.800	3.000	0.110	0.118
E	1.200	1.400	0.047	0.055
E1	2.250	2.550	0.089	0.100
e	0.950 TYP		0.037 TYP	
e1	1.800	2.000	0.071	0.079
L	0.550 REF		0.022 REF	
L1	0.300	0.500	0.012	0.020
θ	0°	8°	0°	8°

SOT-23 Suggested Pad Layout

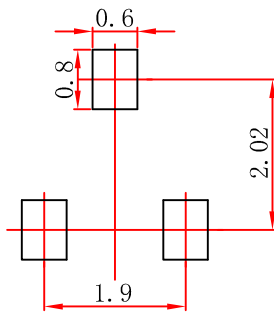

- Note:
1. Controlling dimension: in millimeters.
 2. General tolerance: $\pm 0.05\text{mm}$.
 3. The pad layout is for reference purposes only.

SOT-23 Embossed Carrier Tape

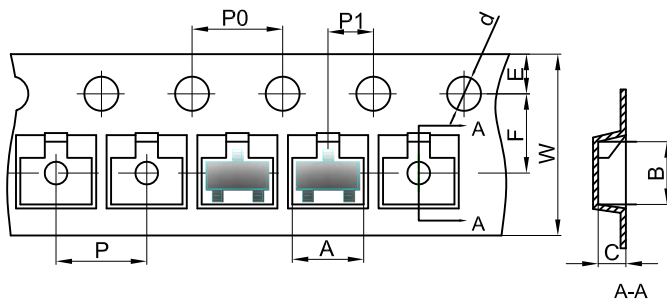

Packaging Description:

SOT-23 parts are shipped in tape. The carrier tape is made from a dissipative (carbon filled) polycarbonate resin. The cover tape is a multilayer film (Heat Activated Adhesive in nature) primarily composed of polyester film, adhesive layer, sealant, and anti-static sprayed agent. These reeled parts in standard option are shipped with 3,000 units per 7" or 17.8cm diameter reel. The reels are clear in color and is made of polystyrene plastic (anti-static coated).

Dimensions are in millimeter

Pkg type	A	B	C	d	E	F	P0	P	P1	W
SOT-23	3.15	2.77	1.22	Ø1.50	1.75	3.50	4.00	4.00	2.00	8.00

SOT-23 Tape Leader and Trailer

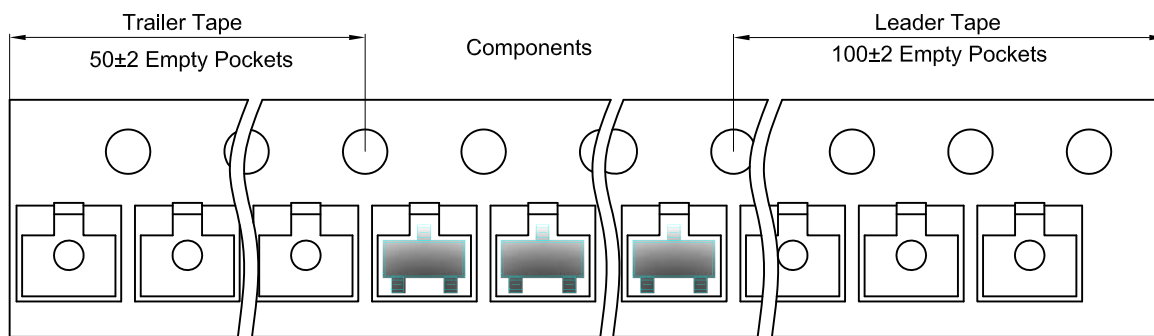

SOT-23 Reel

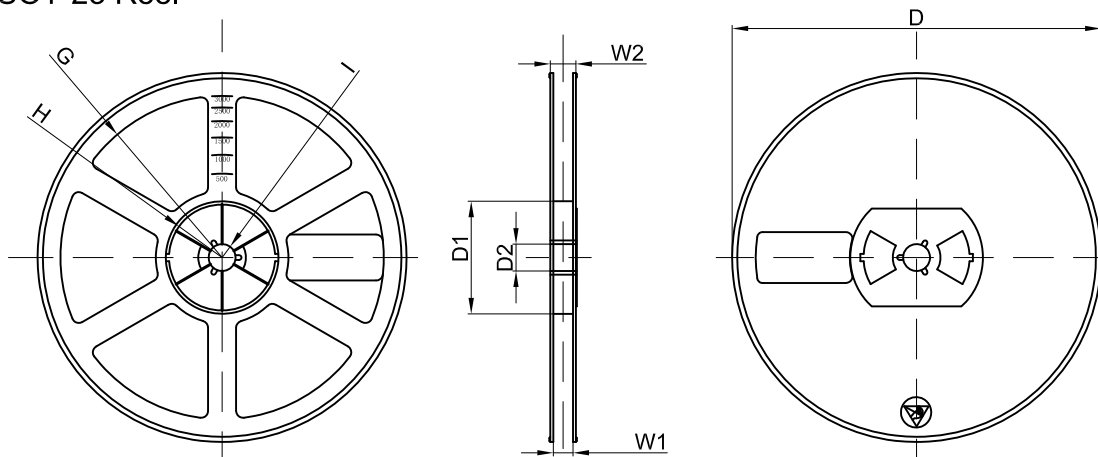

Dimensions are in millimeter

Reel Option	D	D1	D2	G	H	I	W1	W2
7" Dia	Ø178.00	54.40	13.00	R78.00	R25.60	R6.50	9.50	12.30

REEL	Reel Size	Box	Box Size(mm)	Carton	Carton Size(mm)	G.W.(kg)
3000 pcs	7 inch	45,000 pcs	203×203×195	180,000 pcs	438×438×220	