

$V_{(BR)DSS}$	$R_{DS(on)MAX}$	$I_D$
60V	2.5Ω@10V	115mA
	3Ω@5V	

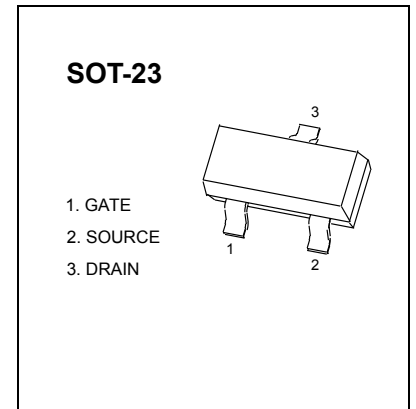

#### FEATURE

- High density cell design for low  $R_{DS(ON)}$
- Voltage controlled small signal switch
- Rugged and reliable
- High saturation current capability

#### APPLICATION

- Load Switch for Portable Devices
- DC/DC Converter

#### MARKING

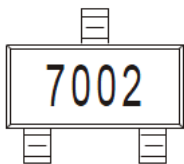

#### Equivalent Circuit

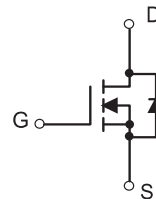

#### MAXIMUM RATINGS ( $T_a=25^{\circ}C$ unless otherwise noted)

Parameter	Symbol	Value	Unit
Drain-Source Voltage	$V_{DS}$	60	V
Gate-Source Voltage	$V_{GS}$	±20	V
Continuous Drain Current	$I_D$	0.115	A
Power Dissipation	$P_D$	0.225	W
Thermal Resistance from Junction to Ambient	$R_{\theta JA}$	556	$^{\circ}C/W$
Junction Temperature	$T_J$	150	$^{\circ}C$
Storage Temperature	$T_{stg}$	-50 ~+150	

T<sub>a</sub>=25 °C unless otherwise specified

Parameter	Symbol	Test conditions	Min	Typ	Max	Unit
Drain-Source Breakdown Voltage	V <sub>(BR)DSS</sub>	V <sub>GS</sub> =0 V, I <sub>D</sub> =250 μA	60			V
Gate-Threshold Voltage	V <sub>th(GS)</sub>	V <sub>DS</sub> =V <sub>GS</sub> , I <sub>D</sub> =250 μA	1	1.6	2.5	
Gate-body Leakage	I <sub>GSS</sub>	V <sub>DS</sub> =0 V, V <sub>GS</sub> =±20 V			±80	nA
Zero Gate Voltage Drain Current	I <sub>DSS</sub>	V <sub>DS</sub> =60 V, V <sub>GS</sub> =0 V			80	nA
On-state Drain Current	I <sub>D(ON)</sub>	V <sub>GS</sub> =10 V, V <sub>DS</sub> =7 V	500			mA
Drain-Source On-Resistance	R <sub>DS(on)</sub>	V <sub>GS</sub> =10 V, I <sub>D</sub> =500mA		0.9	2.5	Ω
		V <sub>GS</sub> =5 V, I <sub>D</sub> =50mA		1.1	3	
Forward Trans conductance	g <sub>fs</sub>	V <sub>DS</sub> =10 V, I <sub>D</sub> =200mA	80			ms
Drain-source on-voltage	V <sub>DS(on)</sub>	V <sub>GS</sub> =10V, I <sub>D</sub> =500mA			3.75	V
		V <sub>GS</sub> =5V, I <sub>D</sub> =50mA			0.375	V
Diode Forward Voltage	V <sub>SD</sub>	I <sub>S</sub> =115mA, V <sub>GS</sub> =0 V	0.55		1.2	V
Input Capacitance *	C <sub>iss</sub>	V <sub>DS</sub> =25V, V <sub>GS</sub> =0V, f=1MHz			50	pF
Output Capacitance *	C <sub>oss</sub>				25	
Reverse Transfer Capacitance *	C <sub>rss</sub>				5	

## SWITCHING TIME

Turn-on Time *	t <sub>d(on)</sub>	V <sub>DD</sub> =25 V, R <sub>L</sub> =50Ω, I <sub>D</sub> =500mA, V <sub>GEN</sub> =10 V			20	ns
Turn-off Time *	t <sub>d(off)</sub>		R <sub>G</sub> =25Ω			

\*These parameters have no way to verify.

**Output Characteristics**

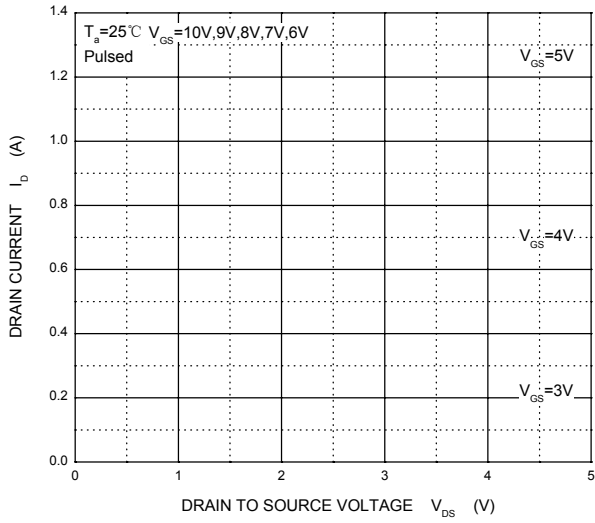

**Transfer Characteristics**

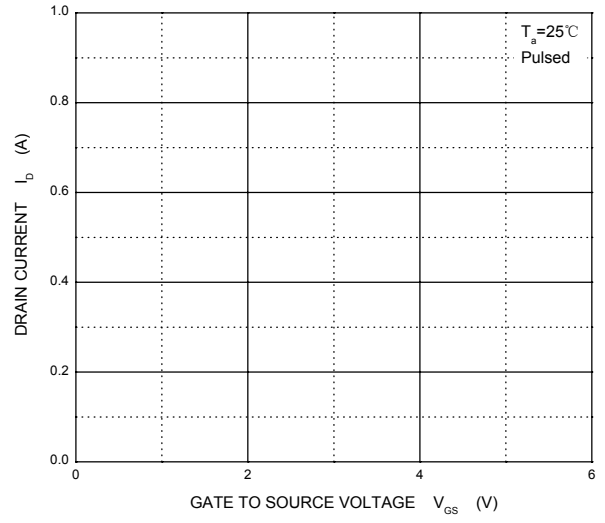

**$R_{DS(ON)}$  —  $I_D$**

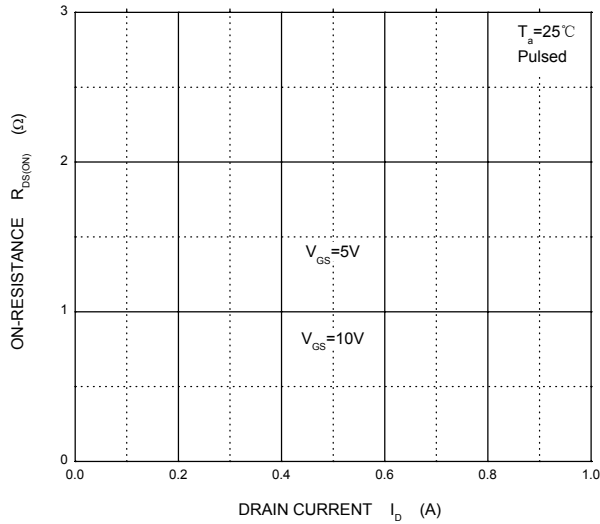

**$R_{DS(ON)}$  —  $V_{GS}$**

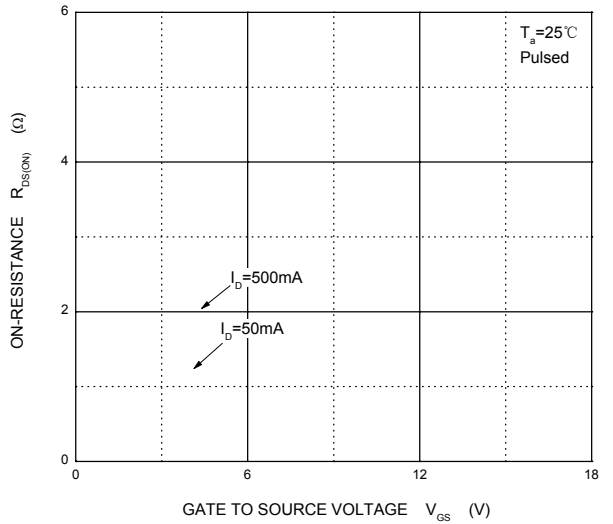

**$I_S$  —  $V_{SD}$**

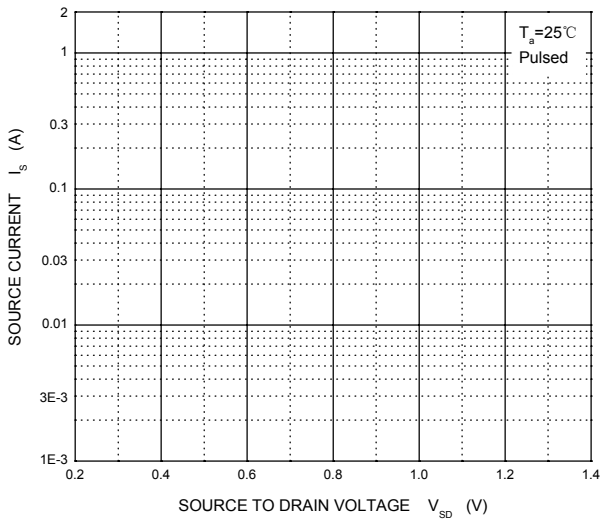

## SOT-23 Package Outline Dimensions

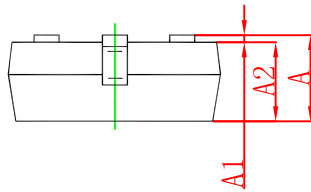
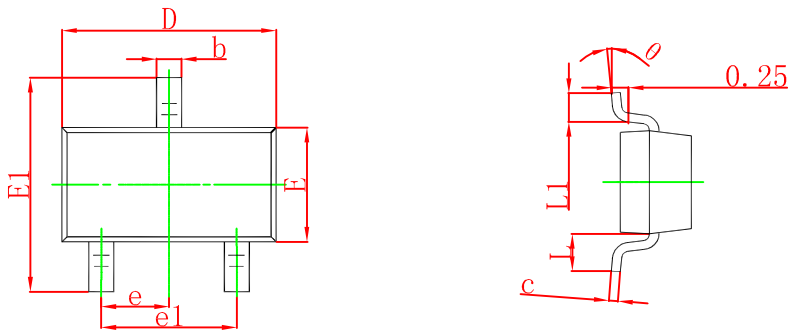

Symbol	Dimensions In Millimeters		Dimensions In Inches	
	Min	Max	Min	Max
A	0.900	1.150	0.035	0.045
A1	0.000	0.100	0.000	0.004
A2	0.900	1.050	0.035	0.041
b	0.300	0.500	0.012	0.020
c	0.080	0.150	0.003	0.006
D	2.800	3.000	0.110	0.118
E	1.200	1.400	0.047	0.055
E1	2.250	2.550	0.089	0.100
e	0.950 TYP		0.037 TYP	
e1	1.800	2.000	0.071	0.079
L	0.550 REF		0.022 REF	
L1	0.300	0.500	0.012	0.020
θ	0°	8°	0°	8°

## SOT-23 Suggested Pad Layout

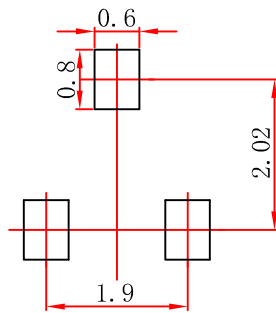

- Note:
1. Controlling dimension: in millimeters.
  2. General tolerance:  $\pm 0.05$  mm.
  3. The pad layout is for reference purposes only.

## SOT-23 Tape and reel

### SOT-23 Embossed Carrier Tape

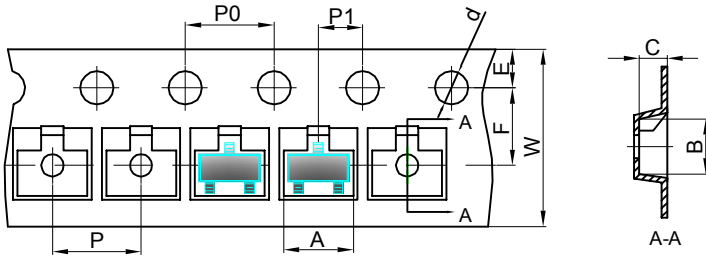

#### Packaging Description:

SOT-23 parts are shipped in tape. The carrier tape is made from a dissipative (carbon filled) polycarbonate resin. The cover tape is a multilayer film (Heat Activated Adhesive in nature) primarily composed of polyester film, adhesive layer, sealant, and anti-static sprayed agent. These reeled parts in standard option are shipped with 3,000 units per 7" or 17.8cm diameter reel. The reels are clear in color and is made of polystyrene plastic (anti-static coated).

Dimensions are in millimeter

Pkg type	A	B	C	d	E	F	P0	P	P1	W
SOT-23	3.15	2.77	1.22	Ø1.50	1.75	3.50	4.00	4.00	2.00	8.00

### SOT-23 Tape Leader and Trailer

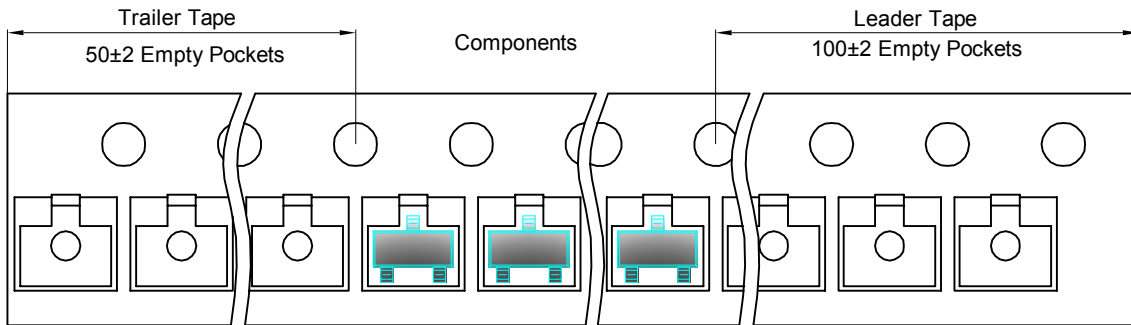

### SOT-23 Reel

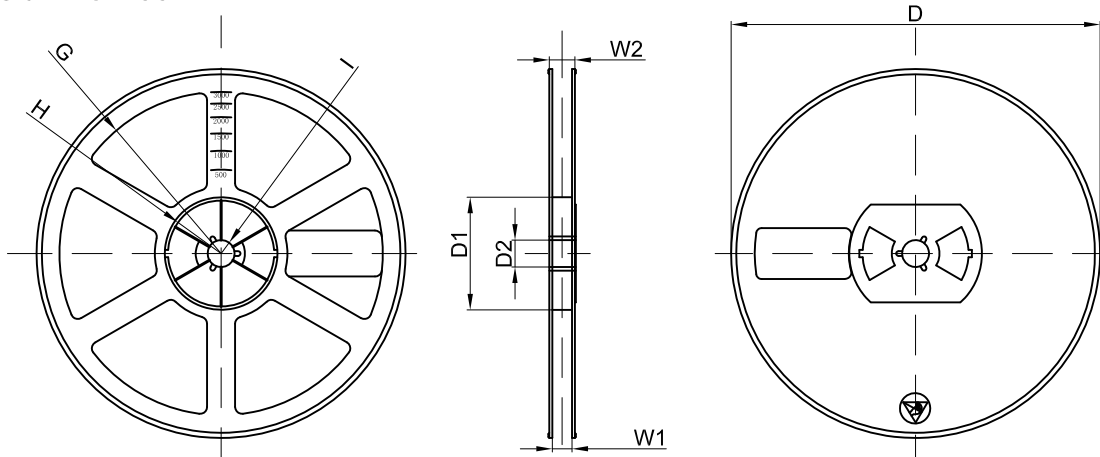

Dimensions are in millimeter

Reel Option	D	D1	D2	G	H	I	W1	W2
7"Dia	Ø178.00	54.40	13.00	R78.00	R25.60	R6.50	9.50	12.30

REEL	Reel Size	Box	Box Size(mm)	Carton	Carton Size(mm)	G.W.(kg)
3000 pcs	7 inch	30,000 pcs	203×203×195	120,000 pcs	438×438×220	